

Material:	Styrofoam, CD-R disc, styrofoam glue.
Finish:	Cut all parts with sharp segmented blade utility knife.

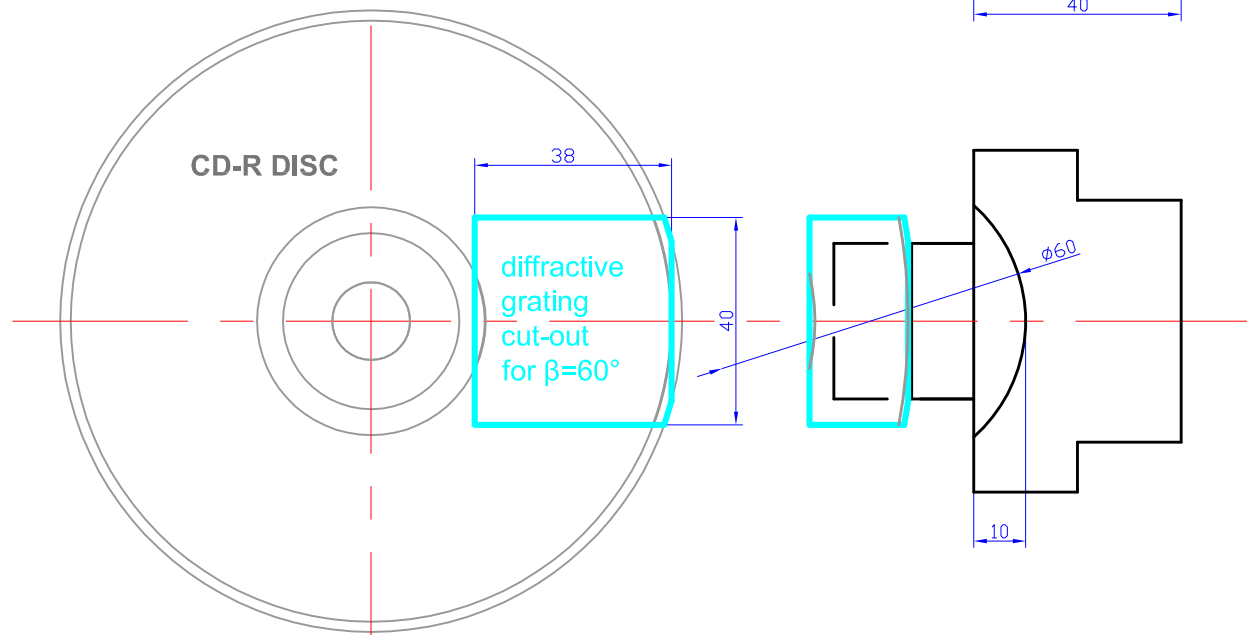

diffractive grating with support

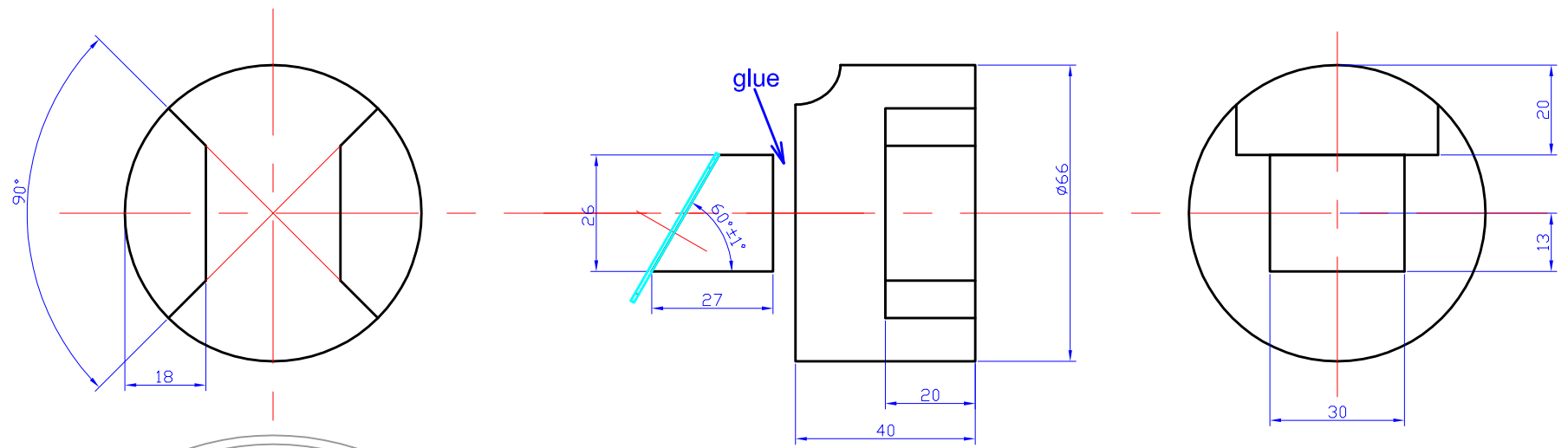

Remarks: none					
Design:	Checkout:	Approval:	Date:	Number of pieces per product:	Scale:
Adam W. Kamela	Adam W. Kamela	Adam W. Kamela	19-07-2014	1	1:1
Adam Wiktor Kamela			Part name: Diffractive grating and support version CD-R $\beta=60^\circ$		
www.kamela.org			Part number: none		
				Sheet: 1 / 1	Editor: 02b